



User manual for

## BeeHive208S

Extremely fast universal 8x 48-pindrive Stand-Alone concurrent multiprogramming system

*Internal PC is driven by Microsoft Windows XP Embedded*



ELNEC s.r.o.  
Presov, Slovakia  
4<sup>th</sup> September 2017

This document is copyrighted by ELNEC s.r.o., Presov, Slovakia. All rights reserved. This document or any part of it may not be copied, reproduced or translated in any form or in any way without the prior written permission of ELNEC s.r.o.

The control program is copyright ELNEC s.r.o., Presov, Slovakia. The control program or any part of it may not be analyzed, disassembled or modified in any form, on any medium, for any purpose.

Information provided in this manual is intended to be accurate at the moment of release, but we continuously improve all our products. Please consult manual on [www.elnec.com](http://www.elnec.com).

ELNEC s.r.o. assumes no responsibility for misuse of this manual.

ELNEC s.r.o. reserves the right to make changes or improvements to the product described in this manual at any time without notice. This manual contains names of companies, software products, etc., which may be trademarks of their respective owners. ELNEC s.r.o. respects those trademarks.

COPYRIGHT © 1997 - 2017  
ELNEC s.r.o.

## Table of contents

<b>Introduction</b> .....	<b>4</b>
BeeHive208S elements.....	7
Manipulation with the programmed device.....	8
In-system serial programming by BeeHive208S.....	8
Selftest and calibration check .....	10
Technical specification .....	12
<b>Programming a device</b> .....	<b>20</b>
Engineering mode .....	20
Production mode .....	24
<b>Software</b> .....	<b>27</b>
Detailed description of Graphics user interface with touch screen.....	27
Administration of build in PC.....	44
<b>Troubleshooting and warranty</b> .....	<b>48</b>
Troubleshooting.....	48
Hardware warnings .....	49
If you have an unsupported target device .....	49
Maintenance .....	50
Warranty terms .....	50

*Please, download actual version of manual from  
ELNEC WEB site ([www.elnec.com](http://www.elnec.com)), if current one  
will be out of date.*

## Conventions used in the manual

References to the control program functions are in bold, e.g. **Load**, **File**, **Device**, etc.  
References to control keys are written in brackets <>, e.g. <F1>.

## Terminology used in the manual:

<b>Device</b>	any kind of programmable integrated circuits or programmable devices
<b>ZIF socket</b>	Zero Insertion Force socket used for insertion of target device
<b>Buffer</b>	part of memory or disk, used for temporary data storage
<b>USB port</b>	type of PC port
<b>HEX data format</b>	format of data file, which may be read with standard text viewers; e.g. byte 5AH is stored as characters '5' and 'A', which mean bytes 35H and 41H. One line of this HEX file (one record) contains start address and data bytes. All records are secured with checksum.

# Introduction

**BeeHive208S** is extremely fast universal 8x 48-pin drive **Stand-Alone concurrent multiprogramming system** designed for high volume production programming with minimal operator effort. The chips are programmed at near theoretical maximum programming speed.

Block scheme of BeeHive208S

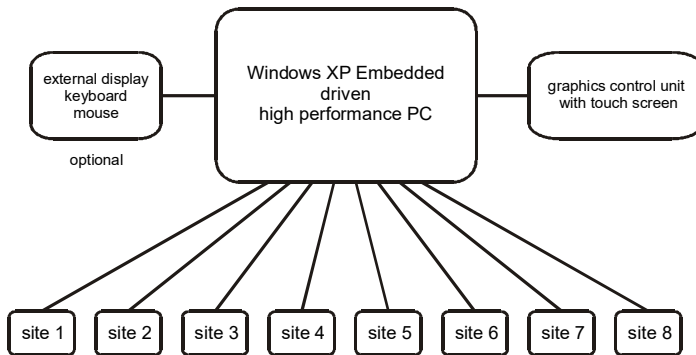

**BeeHive208S** consists of eight independent isolated universal programming modules, based on the **BeeProg2** programmer hardware. Therefore BeeHive208S sockets can run asynchronously (concurrent programming mode). Each programming module starts programming at the moment the chip is detected to be inserted in the socket properly - independently of the status of other programming modules. This results in seven programming modules working while you replace the programmed chip in the eighth.

Graphical control unit with touch screen provides basic control and easy monitoring of the programming flow.

Modular construction of hardware - the programming modules work independently - allows for continuing operation when a part of the circuit becomes inoperable. It also makes service quick and easy.

**Hands-free operation:** asynchronous and concurrent operation allows a chip to begin programming immediately upon insertion of a chip. The operator merely removes the finished chip and inserts a new chip. Operator training is therefore minimized.

**BeeHive208S** supports all kinds and types of silicon technology found in today's and tomorrow's programmable devices without family specific modules. You can be sure that new device support requires the software to be updated and (if necessary) simple

package converter (programming adapter), therefore the ownership costs are minimized.

Using built-in in-circuit serial programming (**ISP**) connector, the programmer is able to program ISP capable chips in circuit.

**BeeHive208S** provides very competitive price coupled with excellent hardware design for reliable programming. It has probably best "value for money" programmer in this class.

**BeeHive208S** provides very fast programming due to high-speed FPGA driven hardware and execution of time-critical routines inside of the programmer. At least programming speed is faster than competitors in this category, for many chips it is much faster than most competitors. As a result, when used in production this programmer waits for an operator, and not the other way round.

**BeeHive208S** provides the two banana jacks, one for ESD wrist strap connection for easy-to-implement ESD protection and the second one for connection to ground.

**FPGA based** totally reconfigurable 48 powerful TTL pindrivers provide H/L/pull\_up/pull\_down and read capability for each pin. Advanced pindrivers incorporate high-quality high-speed circuitry to deliver signals without overshoot or ground bounce for all supported devices. Pin drivers operate down to 1.8V so you'll be ready to program the full range of today's advanced low-voltage devices.

**BeeHive208S** performs **device insertion test** based on the check of proper signal path between the programmer and programmed device before it programs each device. In dependence on programming configuration it identifies missed or poor contact between programmed device and the ZIF socket of the programming adapter (or the programmer directly), missed or poor contact between the programming adapter and the programmer and it's also able to indicate **wrong position** of device in the ZIF socket of the programmer / the programming adapter (moved, rotated, backward oriented). These capabilities, supported by **overcurrent protection** and **signature-byte check** help prevent chip damage due to operator error.

**BeeHive208S** has the selftest capability, which allows the diagnostic part of software to thoroughly check the health of the each programming module.

**BeeHive208S** has a built-in protection circuit for eliminating the damage of programmer and/or programmed device due to environment or operator failure. All ZIF socket pins of BeeHive208S programmer are **protected against ESD** up to 15kV.

**BeeHive208S** performs programming **verification** at the **marginal level** of supply voltage, which, obviously, improves programming yield, and guarantees long data retention.

Various **socket converters** are available to handle devices in PLCC, SOIC, PSOP, SSOP, TSOP, TSSOP, TQFP, QFN (MLF), SDIP, BGA and other packages.

It is important to remember that in most cases new devices require **only a software update** because the BeeHive208S is based on the truly universal (BeeProg2)

programmer. With our prompt service you can have new device added to the list of supported devices within hours! See AlgOR (Algorithm On Request) service for details.

Advanced design of the BeeHive208S Stand-Alone multiprogramming system, including protective circuits, original brand components, and careful manufacturing and long burning-in periods allows us to provide a **three-year warranty** on parts and labor for the programmer (limited 25 000-cycle warranty on ZIF sockets). Although we take as much care as possible to integrate high quality components in the build in computer, we can't provide higher warranty as we get from suppliers. So there is a limited warranty of one year on all computer parts such as touch screen, motherboard, CPU, HD, etc.

This warranty terms are valid for customers, who purchase a programmer directly from Elnec company. The warranty conditions of Elnec sellers may differ depending on the target country law system or Elnec seller's warranty policy.

**Free additional services:**

- free lifetime software update via Web site.

**Free software updates** are available from our Internet address [www.elnec.com](http://www.elnec.com).

- Online technical support is available within promised 24 hours time limit or you may call us during business hours from Monday through Friday 8:30 to 17:30 (CET).
- **Keep-Current** is a service by which ELNEC ships to you the latest version of the control program for programmer and the updated user documentation. A Keep-Current service is your hassle-free guarantee that you always have access to the latest software and documentation, at minimal cost.
- **AlgOR** (Algorithm On Request) service allows you to receive from ELNEC software support for programming devices not yet available in the current device list.

## BeeHive208S elements

- 1) 48 pin ZIF socket
- 2) work result LEDs
- 3) power/sleep LED of site
- 4) YES! Button
- 5) ISP connector
- 6) graphical control unit with touch screen
- 7) fan's grid



- 8) temperature controlled fans
- 9) banana jack for connection to ground
- 10) banana jack for ESD wrist straps connection
- 11) Windows XP Embedded serial number sticker

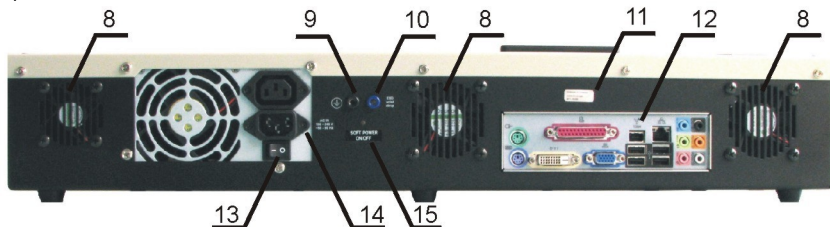

- 12) PC connectors – e.g. for display, keyboard, mouse...
- 13) power switch
- 14) power supply connector
- 15) Soft power ON/OFF button

## Manipulation with the programmed device

After the selection of desired device for your work, you can insert it into the open ZIF socket (lever is up) and close socket (lever is down). The correct orientation of the device in ZIF socket is shown on the picture near the ZIF socket on the programmer cover. The programmed device must be removed from the socket when the BUSY LED is off.

**Note:** *Programmer protection electronics protect the target device and the programmer itself against either short or long-term power failures and, partly, against a PC failure. However, it is not possible to guarantee the integrity of the target device due to incorrect, user-selected programming parameters. Target device may not be destroyed by forced interruption of the control program (turn off programmer), but the content of programmed cells may remains undefined. Don't unplug the target device from the ZIF socket during work with device (BUSY LED on).*

## In-system serial programming by BeeHive208S

Optimized advanced pindrivers deliver programming performance without overshoot or ground bounce for all device technologies. Pin drivers operate down to 1.8V so you'll be ready to program the full range of today's advanced low- voltage devices.

The ISP programming solution performs programming verification at the marginal level of supply voltage, which, obviously, improves programming yield, and guarantees long data retention.

The ISP programming solution provides also the power supply for the target system.

This ISP programming solution provides very competitive price but excellent hardware design for reliable programming.

The software provides full information for ISP implementation: Description of ISP connector pins for currently selected chip, recommended target design around in-circuit programmed chip and other relevant information.

For general definition, recommendation and direction about ISP see section **Common notes / ISP** please.

### Description of ISP connector

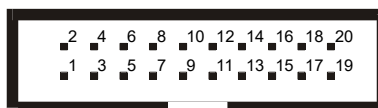

Front view at ISP connector.



## H/L/read driver

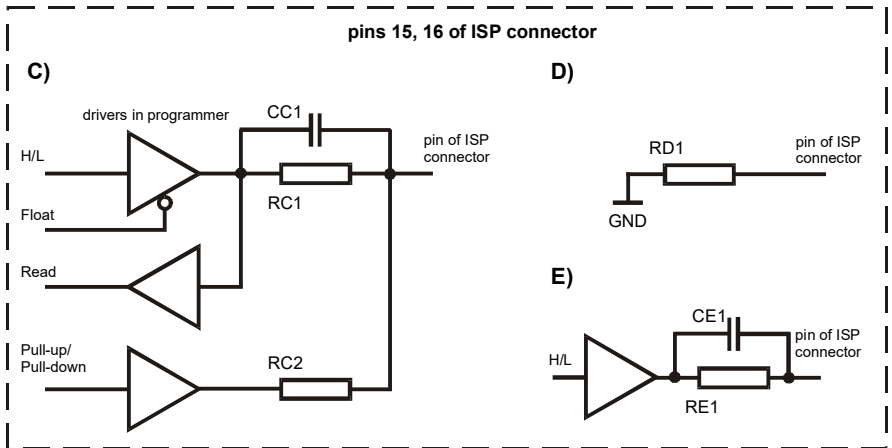
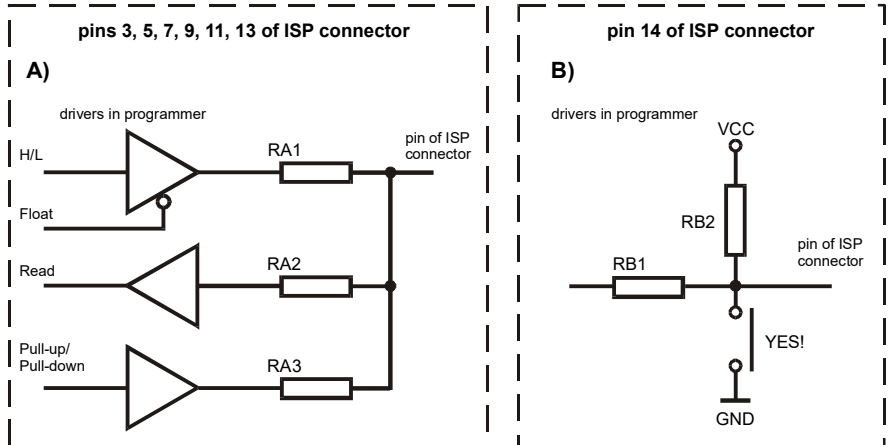

RA1 180R, RA2 1k3, RA3 22k,  
 RB1 10k, RB2 10k,  
 CC1 1n, RC1 1k3, RC2 22k,  
 RD1 22k, CE1 1n, RE1 1k3,

Comment to above picture:

picture C) Connection of pins 15 and 16 when are configured as logical signal needed for ISP programming

pictures D) E) When pins 15 and 16 are configured as status of LED OK and LED ERROR

picture D) before first action with desired ISP device

picture E) after first action with desired ISP device

**Notes:** When LED OK or LED ERROR ON (shine), this status is presented as logical H, level of H is 1,8V - 5V depend on H level of desired ISP device.

When LED OK or LED ERROR OFF (not shine), this status is presented as logical L, level of L is 0V - 0,4V.

The above mentioned values are provided to understand (and also to exactly calculate) the value of resistors, which isolate (separate) the programmed chip and target system.

Specification of ISP connector pins depends on the device, which you want to work with. You can find it in the control SW for programmer (PG4UW), menu **Device / Device Info (Ctrl+F1)**. Note the ISP programming (ISP) option of respective device must be selected. It is indicated by (ISP) suffix after the name of selected device.

These specifications correspond with application notes published by device manufacturers. Application notes can be found on [www.elnec.com](http://www.elnec.com), section **Support / Application Notes**.

**Note:** Pin no. 1 is signed by triangle mark on ISP cable connectors.

As ISP connectors are used 20 pins connectors 09185207813 from Harting or other compatible connector.

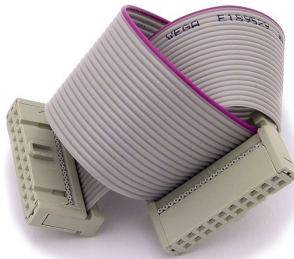

BeeHive208S ISP cable

#### Warnings:

- Use only **attached ISP cable**. When you use other ISP cable (other material, length...), programming may occur unreliable.
- **BeeHive204 can supply** programmed device (pin 1 of ISP connector) and target system (pins 19 and 20 of ISP connector) with limitation (see Technical specification / ISP connector).
- **BeeHive204** apply programming voltage to target device and checks his value (target system can modify programming voltage). If the programming voltage is different as expected, no action with target device will be executed.

## Selftest and calibration check

#### Warning:

Selftest and calibration check can be run in engineering mode only.

This mode is available only when external display, keyboard and mouse are connected to BeeHive208S.

If you feel that your programmer does not react according to your expectation, please run the programmer (ISP connector's) selftest using Diagnostic POD (Diagnostic POD for ISP connectors #2), enclosed with the standard delivery package.

### **Selftest of programmer**

- Insert **48 pin diagnostic POD - type I** into ZIF socket of the programmer. Take care about orientation of **48 pin diagnostic POD - type I** (see top side of POD).
- Run selftest of programmer in PG4UW (Programmer / Selftest plus).

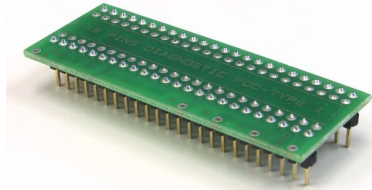

### **Selftest of ISP connector**

- Insert **Diagnostic POD for ISP connectors #2** into ZIF socket of the programmer. Take care about orientation of **Diagnostic POD for ISP connectors #2**.
- Interconnect the 20 pins connector of **Diagnostic POD for ISP connectors #2** with the ISP connector of the programmer with the ISP cable included in delivery with the programmer package. Be sure that the pins are interconnected properly (i.e. 1-1, 2-2, ..., 20-20).
- Run selftest of ISP connector in PG4UW (Programmer / Selftest ISP connector...).

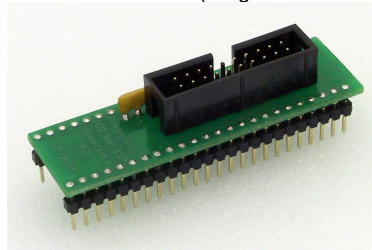

### **Calibration test**

- Insert **48 Pins Calibration test POD, Type I** into ZIF socket of the programmer.
- Run calibration test of programmer in PG4UW (Programmer / Calibration test).

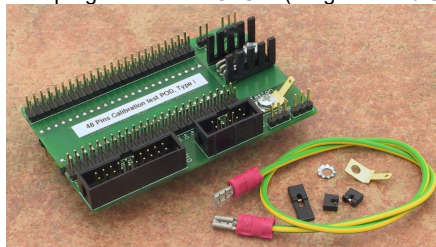

## **Technical specification**

### **Specification (BeeHive208S multiprogramming system)**

- 8x universal programming module (8x 48-pin DIL ZIF sockets and 8x ISP connector)
- operation result LEDs, LED power
- line power input 100-240VAC/60W max.
- banana jack for ESD wrist straps connection
- banana jack for connection to ground

### **Specification (PC system inside of programmer)**

- Microsoft Windows XP Embedded operation system
- PC Intel Core 2 Quad 2.66 GHz
- 2 GB RAM
- 320 GB HDD

### **Specification (valid for each programming module)**

#### **HARDWARE**

##### **Base unit, DACs**

- USB 2.0 high-speed compatible port, up to 480 Mbit/s transfer rate
- on-board intelligence: powerful microprocessor and FPGA based state machine
- three D/A converters for VCCP, VPP1, and VPP2, controllable rise and fall time
- VCCP range 0..8V/1A
- VPP1, VPP2 range 0..26V/1A
- autocalibration/selftest
- selftest capability

##### **Socket, pindriver**

- 48-pin DIL ZIF (Zero Insertion Force) socket accepts both 300/600 mil devices up to 48-pin
- pindrivers: 48 universal
- VCCP / VPP1 / VPP2 can be connected to each pin
- perfect ground for each pin
- FPGA based TTL driver provides H, L, CLK, pull-up, pull-down on all pindriver pins
- analog pindriver output level selectable from 1.8 V up to 26V
- current limitation, overcurrent shutdown, power failure shutdown
- ESD protection on each pin of socket (IEC1000-4-2: 15kV air, 8kV contact)
- continuity test: each pin is tested before every programming operation

##### **ISP connector**

- 20-pin male type with miss insertion lock
- 6 TTL pindrivers, provides H, L, CLK, pull-up, pull-down; level H selectable from 1.8V up to 5V to handle all (low-voltage including) devices.
- 1x VCCP voltage (range 2V..7V/100mA) , can be applied to two pins
- programmed chip voltage (VCCP) with both source/sink capability and voltage sense
- 1x VPP voltage (range 2V..25V/50mA)
- target system supply voltage (range 2V..6V/250mA)

- ESD protection on each pin of ISP connector (IEC1000-4-2: 15kV air, 8kV contact)
- two output signals, which indicate state of work result = LED OK and LED Error (active level: min 1.8V)
- input signal, switch YES! equivalent (active level: max 0.8V)

## **DEVICE SUPPORT (valid for each programming module)**

### **Programmer**

- NAND FLASH: Samsung K9xxx, KFxxx, SK Hynix (ex Hynix) HY27xxx, H27xxx, Toshiba TC58xxx, TH58xxx, Micron MT29Fxxx, (ex Numonyx ex STM) NANDxxx, Spansion S30Mxxx, S34xxx, 3D-Plus 3DFNxxx, ATO Solution AFNDxxx, Fidelix FMNDxxx, Eon Silicon Sol. EN27xxx, ESMT F59xxx, LBA-NAND Toshiba THGVNxxx
- serial NAND FLASH: Micron MT29Fxxx, GigaDevice GD5Fxxx
- eMMC: Hynix H26Mxxxxxxx, Kingston KE44B-xxxx/xxx, Micron MTFCxxxxxx, Numonyx NANDxxxxxxx, Phison PSM4A11-xx, Samsung KLMxxxxxxx, SanDisk SDINxxx-xx, Toshiba THGBMxxxxxxx
- Multi-chip devices: NAND+RAM, NOR+RAM, NOR+NOR+RAM, NAND+NOR+RAM
- Serial Flash: standard SPI, high performance Dual I/O SPI and Quad I/O SPI (25Bxxx, 25Dxxx, 25Exxx, 25Fxxx, 25Lxxx, 25Mxxx, 25Pxxx, 25Qxxx, 25Sxxx, 25Txxx, 25Uxxx, 25Vxxx, 25Wxxx, 25Xxxx, 26Vxxx, 45PExx, MX66Lxxx, S70FLxxx), DataFlash (AT45Dxxx, AT26Dxxx)
- parallel NOR Flash: 28Fxxx, 29Cxxx, 29Fxxx, 29GLxxx, 29BVxxx, 29LVxxx, 29Wxxx, 49Fxxx series, Samsung's K8Fxxxx, K8Cxxxx, K8Sxxxx, K8Pxxxx series, ...
- EPROM: NMOS/CMOS, 27xxx and 27Cxxx series
- EEPROM: NMOS/CMOS, 28xxx, 28Cxxx, 27EExxx series, 3D Plus 3DEExxxxxxx
- mDOC H3: SanDisk (ex M-Systems) SDED5xxx, SDED7xxx, MD2533xxx, MD2534xxx, Hynix HY23xxx
- FRAM: Ramtron
- MRAM: Everspin MRxxxxx8x, 3D Plus 3DMRxxxxxxx
- NV RAM: Dallas DSxxx, SGS/Inmos MKxxx, SIMTEK STKxxx, XICOR 2xxx, ZMD U63x series
- Serial E(E)PROM: Serial E(E)PROM: 11LCxxx, 24Cxxx, 24Fxxx, 25Cxxx, 30TSExxx, 34Cxxx, 34TSxx, 59Cxxx, 85xxx, 93Cxxx, NVM3060, MDAxxx series, full support for LV series, AT88SCxxx
- Serial FRAM: Cypress(Ramtron): FM24xxxxxx, FM25xxxxxx, Fujitsu: MB85RCxxxx, MB85RSxxxx, Lapis(OKI, Rohm): MR44xxxxx, MR45xxxxx
- Serial MRAM: Everspin MH20xxx, MH25xxx
- Configuration (EE)PROM: XCFxxx, XC17xxxx, XC18Vxxx, EPCxxx, EPCSxxx, AT17xxx, AT18Fxxx, 37LVxx
- 1-Wire E(E)PROM: DS1xxx, DS2xxx
- PLD Altera: MAX 3000A, MAX 7000A, MAX 7000B, MAX 7000S, MAX7000AE, MAX II/G/Z, MAX V
- PLD Lattice: ispGAL22V10x, ispLSI1xxx, ispLSI1xxxEA, ispLSI2xxx, ispLSI2xxxA, ispLSI2xxxE, ispLSI2xxxV, ispLSI2xxxVE, ispLSI2xxxVL, LC4xxxB/CV/ZC/ZE, M4-xx/xx, M4A3-xx/xx, M4A5-xx/xx, M4LV-xx/xx, ispCLOCK, Power Manager/II, ProcessorPM
- PLD: Xilinx: XC9500, XC9500XL, XC9500XV, CoolRunner XPLA3, CoolRunner-II
- SPLD/CPLD series: AMD, AMI, Atmel, Cypress, Gould, ICT, Lattice, National Semicond., Philips, STMicroelectronics, TI (TMS), Vantis, VLSI

- FPGA: FPGA: Microsemi(Actel): ProASIC3, IGLOO, Fusion, ProASICplus, SmartFusion
- FPGA: Lattice: MachXO, MachXO2, LatticeXP, LatticeXP2, ispXPGA
- FPGA: Xilinx: Spartan-3AN
- Clocks: TI(TMS), Cypress
- Special chips: Atmel Tire Pressure Monitoring ATA6285N, ATA6286N; PWM controllers: Zilker Labs, Analog Devices; Multi-Phase ICs: IR(Chil Semiconductor); Gamma buffers: AUO, Maxim, TI, ...
- Microcontrollers MCS51 series: 87Cxxx, 87LVxx, 89Cxxx, 89Sxxx, 89Fxxx, 89LVxxx, 89LSxxx, 89LPxxx, 89Exxx, 89Lxxx, all manufacturers, Philips LPC series
- Microcontrollers Intel 196 series: 87C196 KB/KC/KD/KT/KR/...
- Microcontrollers Atmel ARM. AT91SAM7Sxx, AT91SAM7Lxx, AT91SAM7Xxx, AT91SAM7XCxx, AT91SAM7SExx series;
- Microcontrollers Atmel ARM9: AT91SAM9xxx series;
- Microcontrollers ARM Cortex-M3: ATSAM3Axxx, ATSAM3Uxxx, ATSAM3Nxxx, ATSAM3Sxxx, ATSAM20, ATSAM3Xxxx series
- Microcontrollers ARM Cortex-M4: ATSAM4Sxxx series
- Microcontrollers Atmel AVR 8bit/16bit: AT90Sxxx, AT90pwm, AT90can, AT90usb, ATtiny, ATmega, ATxmega series
- Microcontrollers Atmel AVR32: AT32UC3xxxx, ATUCxxxD3/D4/L3U/L4U series
- Microcontrollers TI (Chipcon): CC11xx, CC24xx, CC25xx, CC85xx series
- Microcontrollers Coreriver: Atom 1.0, MiDAS1.0, 1.1, 2.0, 2.1, 2.2, 3.0 series
- Microcontrollers Cypress: CY7Cxxxxx, CY8Cxxxxx
- Microcontrollers ELAN: EM78Pxxx
- Microcontrollers EPSON: S1C17 series
- Microcontrollers Explore Microelectronic: EPF01x, EPF02x series
- Microcontrollers Generalplus: GPM8Fxxx series
- Microcontrollers GreenPeak: GPxxx series
- Microcontrollers Infineon(Siemens): XC800, C500, XC166, C166 series
- Microcontrollers MDT 1xxx and 2xxx series
- Microcontrollers Megawin: MG87xxx, MPC82xxx series
- Microcontrollers Microchip PICmicro: PIC10xxx, PIC12xxx, PIC16xxx, PIC17Cxxx, PIC18xxx, PIC24xxx, dsPIC, PIC32xxx series
- Microcontrollers Motorola/Freescale: HC05, HC08, HC11, HC12, HCS08, RS08, S12, S12X, MC56F, MCF51, MCF52 series, Kinetis (K,L), Qorivva/5xxx Power Architecture
- Microcontrollers Myson MTV2xx, 3xx, 4xx, 5xx, CS89xx series
- Microcontrollers National: COP8xxx series
- Microcontrollers NEC: uPD70Fxxx, uPD78Fxxx series
- Microcontrollers Novatek: NT68xxx series
- Microcontrollers Nordic Semiconductor: nRF24LExxx, nRF24LUxxx, nRF315xx, nRF51xxx Flash and OTP series
- Microcontrollers Nuvoton ARM Cortex-Mx: NUC1xx, M05x, Mini51, Nano1xx series
- Microcontrollers Nuvoton (Winbond): N79xxx, W77xxx, W78xxx, W79xxx, W83xxx series
- Microcontrollers NXP (Philips) ARM Cortex-Mx: LPC11xx, LPC11Cxx, LPC11Dxx, LPC11Uxx, LPC12xx, LPC12Dxx, LPC13xx, LPC17xx, LPC11Axx, LPC11Exx, LPC11xxLV, LPC18xx, LPC43xx, LPC8xx, EM7xx, series
- Microcontrollers NXP (Philips) UOC series: UOCIII, UOC-TOP, UOC-Fighter (TDA1xxxx) series

- Microcontrollers NXP (Philips) ARM7: LPC2xxx, MPT6xx, PCD807xx, SAF7780xxx series
- Microcontrollers NXP (Philips) ARM9: LPC31xx series
- Microcontrollers Pasat: TinyModule DIL40, DIL50 series
- Microcontrollers Scenix (Ubicom): SXxxx series
- Microcontrollers Syntek: STK6xxx series
- Microcontrollers Renesas: R8C/Tiny series, RX series, uPD70Fxxx, uPD78Fxxx series, RL78 series, R32C series
- Microcontrollers SyncMOS: SM39xxx, SM59xxx, SM73xxx, SM79xxx, SM89xxx series
- Microcontrollers & Programmable System Memory STMicroelectronics: uPSD, PSD series
- Microcontrollers STM (ex SGS-Thomson): ST6xx, ST7xx, ST10xx, STR7xx, STR9xx, STM32FL/W, STM8A/S/L series, SPC5 (Power Architecture)
- Microcontrollers Silicon Laboratories(Cygnal): C8051 series
- Microcontrollers Silicon Laboratories(Energy Micro): EFM32Gxx, EFM32GGxx, EFM32LGxx, EFM32TGxx, EFM32WGxx series
- Microcontrollers Silicon Laboratories: SiM3Cxxx, SiM3Lxxx, SiM3Uxxx series
- Microcontrollers Texas Instruments: MSP430 series, MSC12xx series, TMS320F series, CC430 series,
- Microcontrollers Texas Instruments (ex Luminary Micro): LM3Sxxx, LM3Sxxxx series, LM4Fxxxx series, TM4C series
- Microcontrollers ZILOG: Z86/Z89xxx and Z8Fxxxx, Z8FMCxxxxx, Z16Fxxxx, ZGP323xxxxxx, ZLF645xxxxxx, ZLP12840xxxx, ZLP323xxxxxx series
- Microcontrollers other: EM Microelectronic, Spansion(Fujitsu), Goal Semiconductor, Hitachi, Holtek, Novatek, Macronix, Princeton, Winbond, Samsung, Toshiba, Mitsubishi, Realtek, M-Square, ASP, Coreriver, Gencore, EXODUS Microelectronic, Topro, TinyARM, VersaChips, SunplusIT, M-Square, QIXIN, Signetic, Tekmos, Weltrend, Amic, Cyrod Technologies, Ember, Ramtron, Nordic Semiconductor, Samsung, ABOV Semiconductor...
- EPROM: 2708 \*1
- PLD: Bipolar PALxxx \*2

**Notes:**

- *devices marked \* are obsolete, can be programmed with PLD-1 additional module or 2708 additional module*
- *For all supported devices see actual **Device list** at [www.elnec.com](http://www.elnec.com)*

**Programmer, through ISP connector**

- Serial E(E)PROM: IIC series, MW series, SPI series, KEELOQ series, PLD configuration memories, UN I/O series
- 1-Wire E(E)PROM: DS1xxx, DS2xxx
- Serial Flash: standard SPI (25xxx), DataFlash (AT45Dxxx, AT26Dxxx)
- Serial FRAM: Cypress(Ramtron): FM24xxxxxx, FM25xxxxxx, Fujitsu: MB85RCxxxx, MB85RSxxxx, Lapis(OKI, Rohm): MR44xxxxx, MR45xxxxx
- Microcontrollers Atmel: AT89Cxxx, AT89Sxxx, AT89LSxxx, AT89LPxxx, AT90pwm, AT90can, AT90usb, AT90Sxxxx, ATtiny, ATmega, ATxmega series
- Microcontrollers Atmel AVR32: AT32UC3xxxx, ATUCxxxD3/D4/L3U/L4U series
- Microcontrollers Atmel ARM7: AT91SAM7Sxx, AT91SAM7Xxx, AT91SAM7XCxx, AT91SAM7SExx series;
- Microcontrollers TI (Chipcon): CC11xx, CC24xx, CC25xx, CC85xx series
- Microcontrollers Cypress: CY8C2xxxx
- Microcontrollers Elan: EM78Pxxx, EM6xxx series

- Microcontrollers EM Microelectronic: 4 and 8 bit series
- Microcontrollers Microchip PICmicro: PIC10xxx, PIC12xxx, PIC16xxx, PIC17xxx, PIC18xxx, PIC24xxx, dsPIC, PIC32xxx series
- Microcontrollers Mitsubishi: M16C
- Microcontrollers Motorola/Freescale: HC08 (both 5-wire, All-wire), HC11, HC12, HCS08, S12, S12X, MC56F, MCF52, Kinetis K series
- Microcontrollers Nordic Semiconductor: nRF24LExxx, nRF24LUxxx, nRF315xx Flash and OTP series
- Microcontrollers NXP (Philips) ARM7: LPC2xxx, MPT6xx series
- Microcontrollers NXP (Philips) ARM Cortex-Mx: LPC11xx, LPC11Cxx, LPC11Dxx, LPC11Uxx, LPC12xx, LPC12Dxx, LPC13xx, LPC17xx, LPC11Axx, LPC11Exx, LPC11xxLV, LPC18xx, LPC43xx, LPC8xx, EM7xx, series
- Microcontrollers NEC: uPD7xxx series
- Microcontrollers Philips (NXP): LPCxx series, 89xxx series
- Microcontrollers Renesas: R8C/Tiny series, uPD7xxx series
- Microcontrollers Realtek, M-Square
- Microcontrollers Samsung: ICPZBSxxx series
- Microcontrollers Scenix (Ubicom): SXxxx series
- Microcontrollers Silicon Laboratories(Energy Micro): EFM32Gxx, EFM32GGxx, EFM32LGxx, EFM32TGxx, EFM32WGxx series
- Microcontrollers STM (ex SGS-Thomson): ST6xx, ST7xx, ST10xx, STR7xx, STR9xx, STM32F/LW, STM8A/S/L series, SPC5 (Power Architecture)
- Microcontrollers Silicon Laboratories(Cygnal): C8051 series
- Microcontrollers & Programmable System Memory STMicroelectronics: uPSD, PSD series
- Microcontrollers TI: MSP430 series (both JTAG and BSL), MSC12xxx series, CC430 series, LM4F series, TM4C series
- Microcontrollers ZILOG: Z8Fxxxx, Z8FMCxxxxx, Z16Fxxxx series, ZLF645x0xx
- Various PLD (also by Jam/VME/SVF/STAPL/... Player/JTAG support):
- Altera: MAX 3000A, MAX 7000A, MAX 7000B, MAX 7000S, MAX 9000, MAX II/G/Z, MAX V
- Xilinx: XC9500, XC9500XL, XC9500XV, CoolRunner XPLA3, CoolRunner-II
- PLD Lattice: ispGAL22xV10x, ispLS11xxxEA, ispLSI2xxxE, ispLSI2xxxV, ispLSI2xxxVE, ispLSI2xxxVL, M4-xx/xx, M4LV-xx/xx, M4A3-xx/xx, M4A5-xx/xx, LC4xxxB/C/V/ZC/ZE, ispCLOCK, Power Manager/II, ProcessorPM
- FPGA: Microsemi(Actel): ProASIC3, IGLOO, Fusion, ProASICplus, SmartFusion
- FPGA: Lattice: MachXO, MachXO2, LatticeXP, LatticeXP2, ispXPGA

**Notes:**

- For all supported devices see actual **Device list** at [www.elnec.com](http://www.elnec.com).

## Package support

- support all devices in DIP with default socket
- package support includes DIP, SDIP, PLCC, JLCC, SOIC, SOP, PSOP, SSOP, TSOP, TSOPII, TSSOP, QFP, PQFP, TQFP, VQFP, QFN (MLF), SON, BGA, EBGA, FBGA, VFBGA, UBGA, FTBGA, LAP, CSP, SCSP etc.
- support devices in non-DIP packages up to 48 pins with universal adapters
- programmer is compatible with third-party adapters for non-DIP support



## Programming speed

Device	Size [bits]	Operation	Time
K8P6415UQB (parallel NOR Flash)	400100Hx16 (64 Mega)	programming and verify	13 sec
MT29F1G08ABAEAWP (parallel NAND Flash) *2	8400000Hx8 (1 Giga)	programming and verify	51 sec
THGBM3G4D1FBAIG (eMMC NAND Flash) *2	2048 MB x8 (16 Giga)	programming *1	363 sec
QB25F640S33 (serial Flash)	800200Hx8 (64 Mega)	programming and verify	30.7 sec
AT89C51RD2 (microcontroller)	10000Hx8	programming and verify	14.4 sec
PIC32MX360F512L (microcontroller)	80000Hx8	programming and verify	8.9 sec

\*1 implementation is the same as in card readers. Verification of programming is performed internally. Internal controller confirms the proper programming using status register.

\*2 the programming time is for [TurboMode](#) active

### Notes:

- It is important to know, we always use random number patterns for programming speed tests. Some of our competitors use a "sparse" pattern, where only some non-blank data is programmed or are they use data with only a few 0 bits (FE, EF, etc.). This deceptive approach can "decrease" programming times considerably. If you plan to compare, ask always which pattern they use.
- The programming speed depends on the PC speed only slightly.

## SOFTWARE

- **Algorithms:** only manufacturer approved or certified algorithms are used.
- **Algorithm updates:** software updates are available regularly, approx. every 4 weeks, free of charge (Internet download). **OnDemand** version of software is available for highly priority chip support and/or bugs fixes. Available nearly same day.
- **Main features:** revision history, session logging, on-line help, device and algorithm information

### Device operations

#### • standard:

- intelligent device selection by device type, manufacturer or fragment of part name
- automatic ID-based selection of EPROM/Flash EPROM
- blank check, read, verify
- program
- erase
- configuration and security bit program
- illegal bit test
- checksum
- interpret the Jam Standard Test and Programming Language (STAPL), JEDEC standard JESD-71
- interpret the VME files compressed binary variation of SVF files

#### • security

- insertion test
- contact check
- ID byte check

#### • special

- production mode (automatic start immediately after device insertion)
- lots of serialization modes (more types of incremental modes, from-file data, custom generator mode)
- statistics

- count-down mode

### **Buffer operations**

- view/edit, find/replace
- fill/copy, move, byte swap, word/dword split
- checksum (byte, word)
- print

### **File load/save**

- no download time because programmer is PC controlled
- automatic file type identification/recognition

### **Supported file formats**

- unformatted (raw) binary
- HEX: Intel, Intel EXT, Motorola S-record, MOS, Exormax, Tektronix, ASCII-SPACE-HEX, ASCII HEX
- Altera POF, JEDEC (ver. 3.0.A), e.g. from ABEL, CUPL, PALASM, TANGO PLD, OrCAD PLD, PLD Designer ISDATA, etc.
- JAM (JEDEC STAPL Format), JBC (Jam STAPL Byte Code), STAPL (STAPL File) JEDEC standard JESD-71
- VME (ispVME file VME2.0/VME3.0)

## **GENERAL**

- operating voltage AC 90-264V, 47-63Hz
- power consumption max. 300W active
- dimensions 625x465x115 mm (24.6x18.3x4.5 inch)
- weight (programmer) 14.9kg (32.85 lbs)
- temperature 5°C ÷ 35°C (41°F ÷ 95°F)
- humidity 20%..80%, non condensing

### **Package included**

#### **Standard accessories**

- BeeHive208S programmer
- 48 Pins diagnostic POD – Type I (1x)
- diagnostic POD for ISP connector #2 (1x)
- 48 Pins Calibration test POD, Type I (1x)
- ISP cable (8x)
- ZIF anti-dust cover (8x)
- power cordset (1x)
- CD with software and user manual
- quick guide
- leaflet Notes about ESD (1x)
- sticker register your programmer (1x)
- registration card
- calibration test report
- transport case

#### **Bonus pack:**

- USB flash drive
- Antistatic set
- Vacuum handling tool kit
- Gift (surprise)

### ***Additional services***

- Keep Current.
- AlgOR
- free technical support (phone/fax/e-mail).
- free lifetime software update via Web site.

# Programming a device

BeeHive208S can operate in two modes:

<b>Engineering mode</b>	for creating a project
<b>Production mode</b>	for mass production

## Engineering mode

### Warning:

*This mode is available only when external display, keyboard and mouse are connected to BeeHive208S.*

To switch to Engineering mode use **File / Switch to Engineering mode**.

This part of the software is focused on the quick and easy preparation of the project file for use in the production mode of the control software.

Each programming module is driven by an easy-to-use control program with pull-down menu, hot keys and on-line help. Selecting of the device is performed by its class, by manufacturer or simply by typing a fragment of vendor name and/or part number. It is the same time proven software, as is used for all other Elnec single-site programmers. Engineers can use all properties of this software and can make a project for mass production.

Standard device-related commands (read, blank check, program, verify, erase) are boosted by some test functions (insertion test, connection check, signature-byte check), and some special functions (autoincrement, production mode - start immediately after insertion of chip into socket).

All known data formats are supported. Automatic file format detection and conversion are done during loading of file. It is possible to use Jam files (JEDEC standard JESD-71) and VME files

The rich-featured auto-increment function enables one to assign individual serial numbers to each programmed device - or simply increments a serial number, or the function enables one to read serial numbers or any programmed device identification signatures from a user created file.

The software also provides a lot of information about programmed device. For example the **drawings of all available packages**, explanation of **chip labeling** (the meaning of prefixes and suffixes on the chips) are provided.

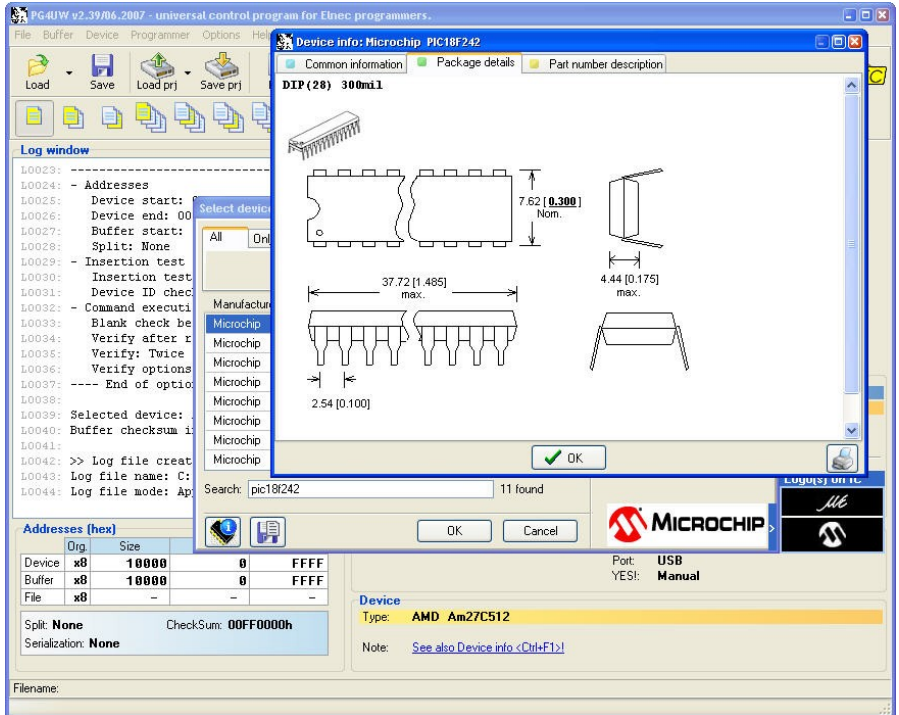

## Make a project

1. Connect external display, keyboard and mouse to PC connectors on back side of programmer. Turn on programmer.



2. Run the control program: double click on  icon.
3. Find BeeHive208S Site (programmer): <Ctrl+F> or right click on panel **Programmer**

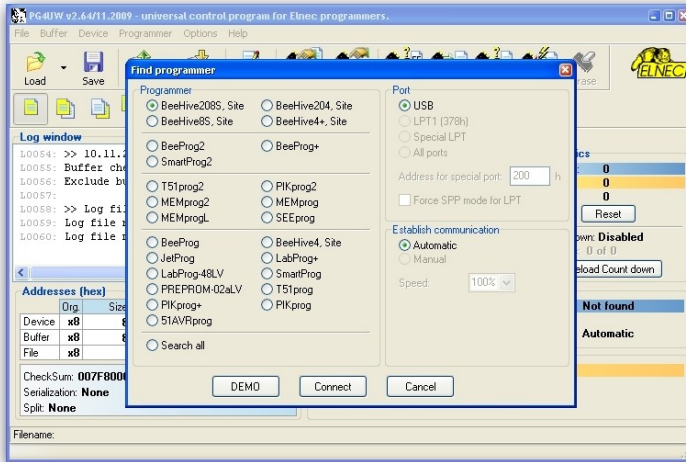

Select BeeHive208S, Site and then click on “Connect” button.

4. Select site.

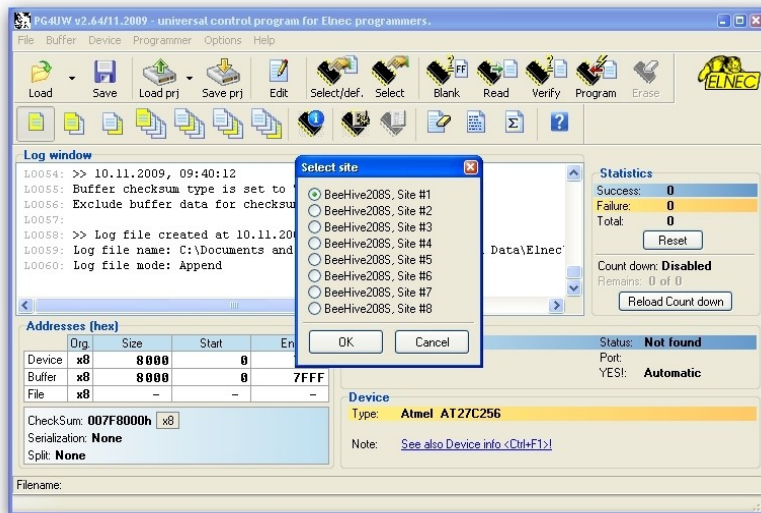

Select desired BeeHive208S Site# and then click on “OK” button

5. Select device: click on  icon and select desired device

6. Load data into buffer from file: click on  icon.
7. Set Device operation options

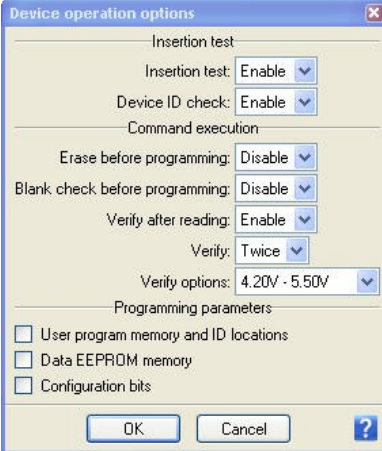

**Device operation options**

Insertion test

Insertion test: Enable

Device ID check: Enable

Command execution

Erase before programming: Disable

Blank check before programming: Disable

Verify after reading: Enable

Verify: Twice

Verify options: 4.20V - 5.50V

Programming parameters

User program memory and ID locations

Data EEPROM memory

Configuration bits

OK Cancel ?

8. To customize device use menu **<Alt+S>**

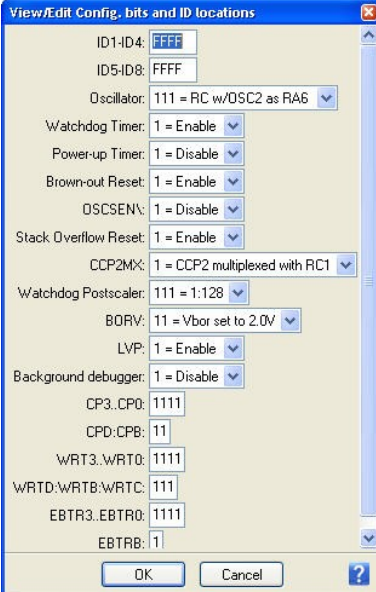

**View/Edit Config. bits and ID locations**

ID1-ID4: FFFF

ID5-ID8: FFFF

Oscillator: 111 = RC w/Osc2 as RA6

Watchdog Timer: 1 = Enable

Power-up Timer: 1 = Disable

Brown-out Reset: 1 = Enable

OscSEN\ : 1 = Disable

Stack Overflow Reset: 1 = Enable

CCP2M\ : 1 = CCP2 multiplexed with RC1

Watchdog Postscaler: 111 = 1:128

BORV: 11 = Vbor set to 2.0V

LVP: 1 = Enable

Background debugger: 1 = Disable

CP3.CP0: 1111

CPD.CPB: 11

WRT3..WRT0: 1111

WRTD:WRTB:WRTC: 111

EBTR3..EBTR0: 1111

EBTRB: 1

OK Cancel ?

Set desired settings for the device and then click on "OK" button

**Note:** Menu Device operation options and **<Alt+S>** depend on the selected device.

9. Save project: click on  icon and select destination folder, write a description of project etc.

You can make a project on other ELNEC programmers (BeeProg2...) too.

For more details see Help for PG4UW (single site driver) and "User manual for all ELNEC programmers".

The latest manual may be found at [www.elnec.com](http://www.elnec.com) part download.

## Production mode

There are two modes:

- Mode A:** without external display, keyboard and mouse connected to BeeHive208S. Programming control is only via built in display with touch screen.
- Mode B:** with external display, keyboard and mouse connected to BeeHive208S. Programming control is via **PG4UWMC** displayed on external display.

**Warning:** *External display, keyboard and mouse not needed in this mode.*

This part of the software is focused on the easy monitoring of high-volume production operations via graphical control unit with touch screen.

The user can control the following basic operations:

- load project file
- connect/disconnect programmer sites
- select desired device master operation (blank check, verify, program, erase)
- start/stop device operation on connected programmer sites
- set some advanced options to customize available settings, for example Automatic YES! Function
- create Job report
- create Problem report
- copy project file(s) from external drive (for example from network drive, USB key etc.) to the standalone's local [Projects] folder
- see the progress of device operation, including statistics information, serialization...

## Step by step instruction

### Starting Stand-Alone multiprogramming system

1. **Check** if the power switch placed at back side of programmer, near power supply connector is on position '0'.
2. **Plug** the power cord in to the programmer power supply connector and turn on the programmer by the power switch placed at back side of programmer. If programmer not starts (cooling fans not start) please, push the "Soft power ON/OFF" button on back side, bellow banana jacks.



3. When the built-in computer is turned on the **operating system** will start booting-up, cooling fans should start to work, and **"Wait please"** screen should be displayed on graphical control unit.
4. Starting of the operating system can take some time normally this time is shorter than 1 minute.
5. After the operating system has successfully started, the **PG4UWMC** control program will start **automatically**. When the PG4UWMC is ready to work the **"Welcome"** screen is displayed on graphical control unit.
6. Click the **OK** button on **"Welcome"** screen to continue. The main screen with menus and **Status** panel should appear on graphical control unit.

#### **Checking if the sites are ready to be connected**

7. When **first starting** Stand-Alone multiprogramming system, or when error message **"Programmer Sites not found"** is displayed, then programmer software must be reinitialized by action **"Search for Programmers..."** available in menu **"Programmer / Search for Programmers..."**.
8. In dialog Search for Programmers use button **"Search"** to search for present programmer sites. The result of search will be displayed in table Search results in Search dialog. When programmer sites are successfully found, then programmer type and its serial number is show in the table Search result. Detected programmer can be accepted by pressing/touching **Accept**. If no complete programmer was found, then **"No Programmers found"** message will be displayed in table Search results and button Accept will be disabled.
9. If search result is **"No Programmers found"**, please try to turn off Stand-Alone programmer, by menu **"File / Shut down computer"**, turn off the power button on the back Side of programmer, **wait for 15 seconds** or more and start programmer again. If the search result is still "No Programmers found", please refer to troubleshooting documentation.

#### **Starting programmer sites**

10. Each programmer site is uses its own **hidden** control application **PG4UW**.
11. To start the hidden applications of control programmer sites, use menu **"Programmer / Connect Sites"**.
12. The **"Connecting sites"** indicator is displayed during connection of sites. Additional information about site connection progress is displayed for each site in panel Status on main screen.
13. Programmer sites are numbered from #1 to #8 in direction of physical placement of programmer sites from left to right.
14. When connection process of programmer sites is complete, indicator **"Connecting Sites"** will be hidden. Panel Status will contain information about each site.

#### **Loading project file**

15. When site status after connection is **"Ready"** or **"No project file is loaded"** user can begin the Load project operation accessible from menu **File / Load project**. The project file can be loaded from default directory **[Projects]** or from any other location, for example from USB key. For more details about Load project, refer to the chapter "Menu File" and Load project. When Load project operation is **successfully** done for all Sites, the **"Ready"** status must be displayed in panel Status on touch screen for all connected Sites. If there are some Sites with different status, use troubleshooting documentation to resolve the problem.

#### **Selection of predefined device operation**

16. Use menu **"Device / Predefined operation"** to select device Master operation. Following Master operations are available:

Blank check  
Verify  
Program  
Erase

For more details about predefined device operations, see chapter **Menu Device / Predefined operation**.

**Insertion of devices in programmer sockets and start device operations**

17. Insert devices into programmer sockets and press **Run <operation>** button on touch screen. <operation> means predefined operation, for example when predefined operation is "Program device", the caption of button Run will be "Run Program".
18. Selected device operation including suboperations that are part of predefined device operation will **start**. Progress of operations is displayed in panel status for each programmer site.

You can use some special features of Stand-Alone multiprogramming system, for example Count down or Statistics.

# Software

## Detailed description of Graphics user interface with touch screen

### Wait please screen

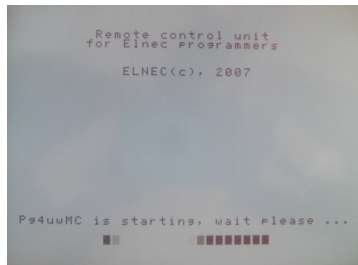

Wait please screen is displayed on standalone's built-in LCD screen as the first screen after turning-on power. The screen is shown during booting up of operating system and starting of standalone control software PG4UWMC.

### Welcome screen (About screen)



Welcome screen is displayed on Stand-Alone build-in LCD screen after successful starting of standalone control software. The screen can also be displayed by using menu command **Help / About** more information see **Help / About**.

Welcome screen can be closed by clicking on button **OK**.

## LCD main screen

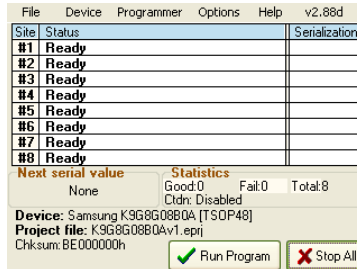

Main screen consists of following parts:

- Menu: File Device Programmer Options Help
- Table with information about programmer sites (site and serialization status)
- Panel Next serial value
- Panel Statistics
- Recently selected device name
- Recent project name
- Checks of data stored in data buffer for currently selected device
- button Run... ( ... can be operation name, for example Program, Verify, Erase)
- button Stop All

### Menu: File Device Programmer Options Help

Each menu item represents one menu command. For detailed information about menu commands, refer to menu commands description chapter.

### Table with information about programmer sites (site and serialization status)

Table contains key information about current status of programmer sites and serialization information for each Site. If serialization is not used, the Serialization column remains empty. Sites that are not connected, have '-' displayed in the Status column. Connected Sites have their Status displayed. Following are typical values:

- Ready means the programmer site is connected and ready to start any operation
- Present special status of connected Site, means the site is connected but it is also not selected (checked in dialog Select Sites). User selected device or project operations will not run on (unselected) Sites. User can set Site selection in dialog 'Select Sites' accessible by menu command **Programmer / Select Enabled Sites**.
- No project file is loaded means the Site is successfully connected but no project file is loaded. It also means that no device is selected. The recommended action is "Load project".
- other text describes current status of Site(s), for example:
  - 'Loading data from disk to buffer'
  - 'Programming device... 85%
  - 'Programming device... OK
  - 'Please insert a new device into socket'

**Next serial value**

When serialization is active, the panel displays current serialization mode and serialization number or label that will be used for next device programmed. Recent serial numbers used for each device are displayed in table Site and serialization status in column Serialization.

**Statistics**

Panel contains information about the number of device operations processed and actual count down status. For more details see Statistics dialog (menu **Options / Statistics**).

**Recently selected Device name**

Manufacturer and name of recently selected devices.

**Recent Project name**

Currently loaded project file name.

**Checksum** of data stored in data buffer for currently selected device.

**Button Run...** (... can be operation name, for example Program, Verify, Erase)

Click on button Run... will start selected device operation for all connected programmer sites. Button can be used when no device operation is running on any programmer site.

**Button Stop**

Click on button Stop will stop executing of currently running device operation on all connected programmer sites.

## Menu File

### File / Load project

This menu command opens dialog 'Load project', where user can choose, from which location the project file has to be loaded and load selected project.

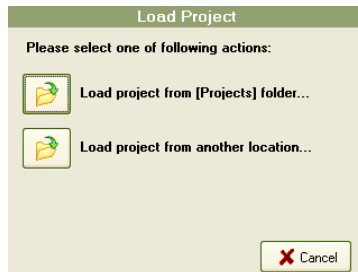

Two options are available:

1. Load project from [Projects] folder...
2. Load project from another location...

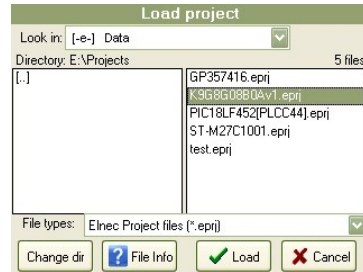
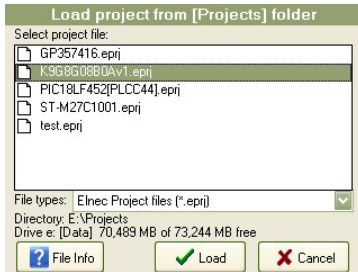

When option 1 is selected, dialog with list of project files present in **[Projects]** folder will appear. User can select desired project and load the project by clicking on **'Load'** button. Dialog can be closed by **'Cancel'** button. Also basic information about selected project file can be displayed by clicking **'File info'** button.

When option 2 is selected, a dialog with list of project files at specified drive and folder will appear. User can select desired drive, folder and project file and load the project by clicking on **'Load'** button. **'Change dir'** button is used to change current directory to directory selected in **'Directory'** list on the left side of dialog. When folder **[.]** is selected, **'Change dir'** button jump up from current directory one level (one folder) up.

**Note:** The drive combo box is automatically refreshed each time it is dropped down. It is useful for loading project files from USB key which can be plugged temporarily into USB port of standalone programmer and consequently new drive letter assigned with USB key will appear in list of available drives.

## File / Manage projects

Manage project dialog offers two options:

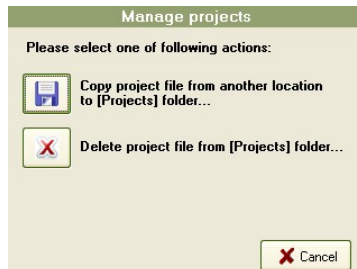

1. Copy project file from another location to [Projects] folder...
2. Delete project file from [Projects] folder...

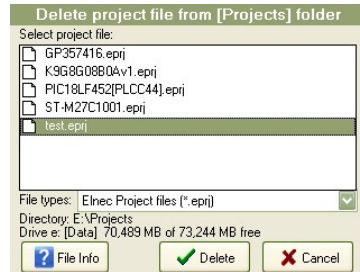
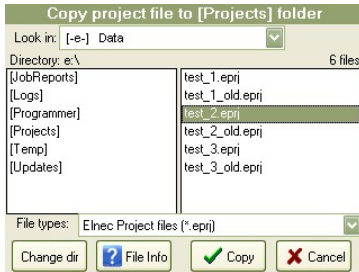

When option 1 is selected, the dialog with list of project files at specified drive and folder will appear. User can select desired drive, folder and project file and copy the selected project to the **[Projects]** folder by clicking on '**Copy**' button. '**Change dir**' button is used to change current directory to directory selected in '**Directory**' list on the left side of dialog. When folder **[.]** is selected, '**Change dir**' button jumps from current directory one level (one folder) up.

**Note:** The drive combo box is automatically refreshed each time it is dropped down. It is useful for loading project files from USB key, which can be plugged temporarily to USB port of standalone programmer and consequently the new drive letter assigned with USB key will appear in list of available drives.

When option 2 is selected, the dialog with a list of project files present in **[Projects]** folder will appear. User can select desired project and delete selected project by clicking on '**Delete**' button. The dialog can be closed by '**Cancel**' button. Also basic information about selected project file can be displayed by clicking '**File info**' button.

### **File / Make Job Report...**

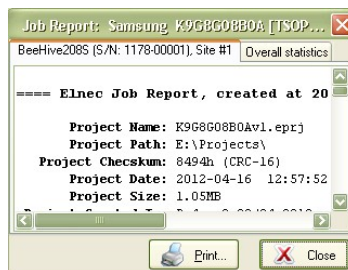

When this menu command is selected, a **Job Report** will be created and displayed in the Job Report window. Before displaying the **Job Report**, the information message is displayed. The information message also contains information about the file name to which the Job Report will be saved.

## File / Switch to Engineering mode

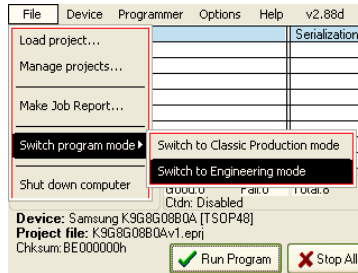

Command is used to start PG4UW control program in **Engineering mode**. In this mode, user can use PG4UW software to select any device from the list of supported devices, set options for the device, load data files for device, test the device operations on any programmer site and create a project file which can be used in production mode. More information about Engineering mode is available in chapter Engineering mode.

To switch back to production mode just **close PG4UW** control program and run program PG4UWMC by double-clicking on PG4UWMC icon on the Desktop.

### Note:

*Engineering mode requires connection of external VGA monitor, keyboard and mouse. Do not use this menu option, without these peripherals connected and working.*

## File / Shut down computer

Command is used to close control program and to shut down built-in computer. It is similar, to command "Shut down" in Microsoft Windows operating systems.

## Menu Device

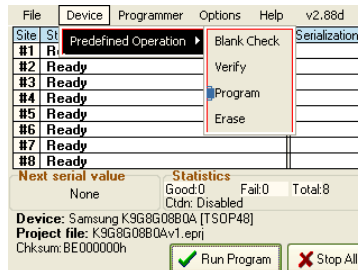

## Device / Predefined operation

This menu allows user to select device Master operation. Following Master operation are available:

- Blank check
- Verify
- Program
- Erase



Each Master operation can consist of a sequence of one or more partial operations, for example Program device operation can consist of the following sub-operations:

- 1.Erase
- 2.Program
- 3.Verify

Selection of sub-operations is stored in Project file. For details about project file creation and usage, refer to Engineering mode chapter.

Preselected device operation can be started by button Run <operation\_name> displayed on main screen.

## Menu Programmer

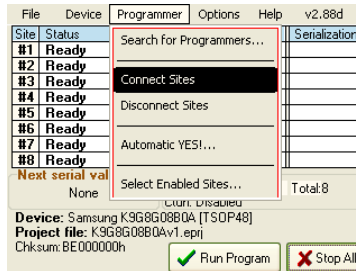

## Programmer / Search for programmers...



Menu command displays the dialog “**Search programmers**”, which is used to reinitialize software configuration, and to re-find available programmer sites. There is no need to use this menu command in normal operation. Situations, when the command is useful are:

1. when first starting BeeHive208S Stand-Alone multiprogramming system
2. when error message “Programmer Sites not found” is displayed

In the dialog “**Search Programmers**” use button “**Search**” to search for attached programmers. The result of search will be displayed in table **Search results** in Search dialog. When programmer sites are successfully found, the result shows the programmer type, and allows you to accept new settings by button **Accept**. Otherwise “**No Programmers found**” message will be displayed in table **Search results** and button **Accept** is disabled.

If search result is “**No Programmers found**”, please try to turn off Stand-Alone programmer, by menu “**File / Shut down computer**”, turn off the power button on the back side of programmer, wait for 15 seconds or more and start programmer again. If the search result is still “**No Programmers found**”, please refer to troubleshooting documentation.

### **Programmer / Connect Sites**

Menu command starts control applications for all available programmer sites. The “**Connecting Sites**” indicator is displayed during connecting of sites. Additional information about site connection progress is displayed for each site in the **Status** panel on the main screen.

Programmer sites are numbered from #1 to #8 in direction of physical placing of sites from left to right.

When connection process of is complete, indicator “**Connecting Sites**” will be hidden. The **Status** panel will contain information about each site. Following status information are most common:

- Ready means the programmer site is connected and ready to start any operation
- Present special status of connected site, means the site is connected but it is also not selected (checked in dialog Select sites). User selected device or project operations will not run on Present (unselected) sites. User can set site selection in dialog ‘**Select sites**’ accessible by menu command ‘**Programmer / Select Enabled sites**’.
- No project file is loaded – means the site is successfully connected but no project file is loaded. It also means that no device is selected. The recommended action is “**Load project**”.
- other text describes current status of site(s)

### **Programmer / Disconnect Sites**

Menu command is used to disconnect all programmer sites and close Programmer sites control applications. The command will apply only if no device operation is currently running on any of connected sites. The command does not close main control program. Also Stand-Alone programmer computer remains running.

### **Programmer / Automatic YES!...**

Command displays dialog “**Site settings**” with Automatic YES! options.

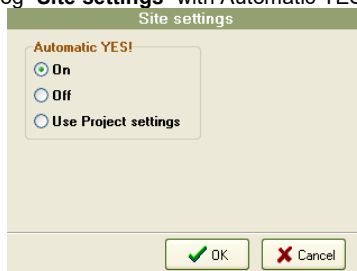

Three modes of Automatic YES! function are available:

- On Automatic YES! Is always On
- Off Automatic YES! Is always Off
- Use Project settings Automatic YES! setting depends on relevant settings stored in project file

When Automatic YES! mode is **On**, programmer sites are scanning their device sockets after device operation is completed. The control program can detect removing of programmed device and insertion of new device and afterwards automatically start (repeat) recent operation on new device. So operator does not need to press any key or button, to program next device.

When Automatic YES! mode is **Off**, operation on next device can be started manually, by pressing the YES! button near each programmer site socket. Each programmer site has its own YES! button.

Status of the active Automatic YES! function is displayed on the bottom left side of LCD main screen with label **Automatic YES! is On** by following:

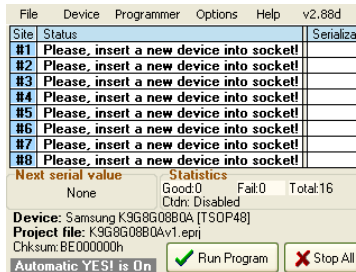

If the Automatic YES! function is Off, no label about Automatic YES! is displayed.

For more details about Automatic YES! feature see PG4UW documentation chapter **Programmer / Automatic YES!**.

### **Programmer / Select Enabled Sites...**

Command displays dialog "Select Enabled Sites".

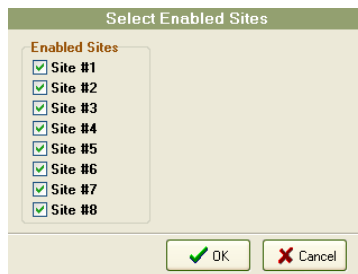

This dialog is used to select sites that have to be used. Each site is represented by one check box. If the check box #n is checked, it means the site #n is selected, and device operations will run on it. If the check box #n is unchecked, the site #n is unselected, so no device operations will run on the Site. The sites can be set as selected or unselected anytime needed, except during running device operation.

## Menu Options

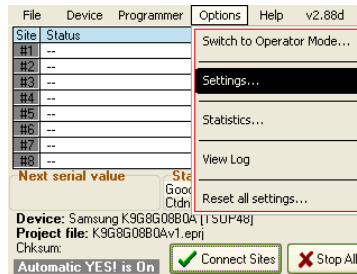

### Options / Switch to Operator Mode... Switch to Administrator Mode

Program PG4UWMC is set by default to **Administrator Mode**. It means, no operation blocking for user is applied. But in production, there is suitable to block some menu commands, to ensure, user does not modify important program settings or configuration. **Operator Mode** is used for this purpose.

PG4UWMC has **Operator Mode** very similar to **Protected mode** of program PG4UW. The difference is, that Operator Mode can be activated by menu command but cannot be activated by Project file. Another difference is that Operator Mode settings of PG4UWMC are saved to configuration .ini file of PG4UWMC while program PG4UWMC is closed. During next start of application PG4UWMC the recent Operator Mode settings obtained from .ini file are used. If you wish to see more information about **Protected mode** of single application PG4UW, please look at Options / Protected mode.

There is menu command - **Options / Switch to Operator Mode...** that allow using Operator Mode in PG4UWMC. After selecting the menu, **Switch to Operator Mode** dialog appears. User has to enter password twice to confirm the password is correct. After successful password confirmation program switches to Operator Mode.



**Keep "Load project" operation allowed** is set to inactive state by default - it means the Load project operation button and menu will be disabled when Operator Mode is active. If the option is enabled (checked), the Load project operation button and menu will be allowed in Operator Mode.

Command **"Load project"** in Operator Mode can also be disabled automatically, by loading of protected project file that has set Protected mode option not to allow another

project load. To enable Load project command again, Administrator Mode of PG4UWMC must be entered.

To switch program from Operator Mode back to Administrator Mode, use the menu command **Options / Switch to Administrator Mode...** The "Password required" dialog appears. User has to enter the same password as the password entered during switch to Operator Mode.

Indication of both modes in software:

When Administrator Mode is active, the blue label Administrator Mode is visible in right top corner of Programmers activity log.

When Operator Mode is active, the yellow label Operator Mode is visible in right top corner of Programmers activity log.

**Notes:**

*Sometimes when Administrator Mode is switched from Operator Mode, some commands (for example command "Load project") may remain disabled. This can be resolved by clicking on button **Stop ALL**.*

*Operation "Load project" for protected project files uses project defined allowed device operations to enable/disable device operations in PG4UWMC. Also "Load project" operation can be automatically disabled in Operator Mode of PG4UWMC. This is applied only when option "Use Site #1 project for all Sites" is selected. If the option is turned off, each Site will have its own project file, and no menu operations blocking forced by project settings will be performed. All operation protection settings from protected projects will be ignored.*

**Options / Settings...**

Command displays dialog "**Settings**" with list of options, user can choose from and set their properties and/or settings.



## Log file...

Log file settings screen looks as following:

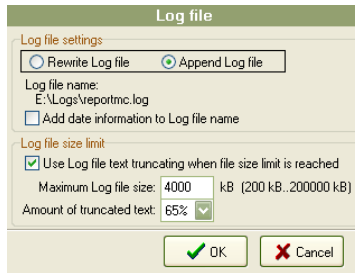

**Log file** is text file containing information about PG4UWMC control program operation flow, which means information about loading project files, device operation types and device operation results.

Main **Log file** name in Stand-Alone programmer can not be modified by user, it has defined value **E:\Logs\reportmc.log** where drive E: is placed on built-in disk of Stand-Alone programmer.

Multiprogramming system generates a few Log files. One main Log file is generated for program PG4UWMC and other Log files are generated for each of the running Programmer Sites. Each site has its own Log file. The name of the site's Log file has the same prefix as the name of the Log file specified in the edit box Log file. The file name prefix is followed by the number of the site in the form of **\_#<Snum>**. All Log files are placed into the folder **E:\Logs\reportmc.log** where drive E: is placed on built-in disk of standalone programmer.

The Log file names used are:

reportmc.log	PG4UWMC main Log file
reportmc_#1.log	Site's #1 Log file
reportmc_#2.log	Site's #2 Log file
reportmc_#3.log	Site's #3 Log file
and so on...	

Following options can be set for Log file creation:

- option **Append Log file** sets usage of Log file. Log file will be created after the first restart of PG4UWMC. For all following executions of PG4UWMC, the existing Log file will be preserved and new data will be appended to the existing Log file.
- option **Rewrite Log file** sets usage of Log file on. Log file will be created after the first restart of PG4UWMC. For all other following executions of PG4UWMC, the existing Log file will be rewritten and new Log file will be created. Data from previous Log file will be deleted.
- Checkbox **Add date information to Log file name** allows user to choose additional date information into Log file name. When the checkbox is checked, the program automatically adds current date string into Log file name through the following rules:

If log file name has format:

<log\_file\_name>.<log\_file\_extension>

The name with added date will be:

<log\_file\_name><-yyyy-mmm-dd>.<log\_file\_extension>

The new part representing the date consists of yyyy - year, mmm - month and dd - day.

**Example:**

Log file name is **E:\Logs\reportmc.log**

The final log file name with added date will look like this July, 7th, 2007):

**E:\Logs\reportmc-2007-jul-07.log**

**Advanced options about Log file size limit:**

- option **Use Log file text truncating when file size limit is reached** - when checked, the Log file size limit is on. It means that when Log file size reaches specified value, the part of text included in Log file will be truncated. When the option is unchecked, the size of Log file is unlimited, respectively is limited by free disk space only.
- option **Maximum Log file size** specifies the maximum size of Log file in kBytes.
- option **Amount of truncated text** specifies the percentage of Log file text, which will be truncated after Maximum Log file size is reached. The higher value means more text will be truncated (removed) from Log file.

**Job report...**

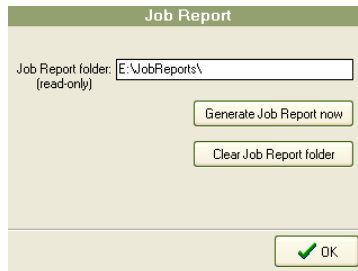

The "Job Report" dialog box features a title bar with the text "Job Report". Below the title bar, there is a text input field labeled "Job Report folder: (read-only)" containing the path "E:\JobReports\". To the right of this field are two buttons: "Generate Job Report now" and "Clear Job Report folder". At the bottom right of the dialog is an "OK" button with a green checkmark icon.

Job Report settings dialog contains following controls:

Text box **"Job Report folder" (read-only)** contains information about folder, where Job report files are saved to.

Button **"Generate Job Report now"**

generates and save new Job Report file to Job Report folder.

Button **"Clear Job Report folder"**

offers option to delete all Job Report files stored in Job Report folder.

**Display settings...**

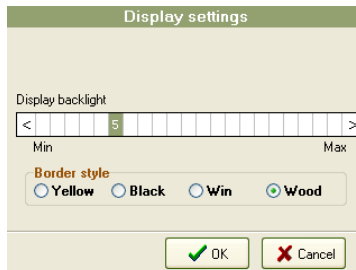

The "Display settings" dialog box has a title bar with the text "Display settings". Below the title bar, there is a section labeled "Display backlight" with a slider control. The slider has a range from "Min" to "Max" and a central value of "5". Below the slider is a section labeled "Border style" with four radio button options: "Yellow", "Black", "Win", and "Wood". The "Wood" option is selected. At the bottom of the dialog are two buttons: "OK" with a green checkmark icon and "Cancel" with a red X icon.

**Display backlight** allows user to control backlight intensity.  
**Border style** offers options to set color for unused part of LCD screen (left and right borders).

### Touchpad calibration...

Command is used for calibration of built-in touch pad, part of built-in LCD touch screen.

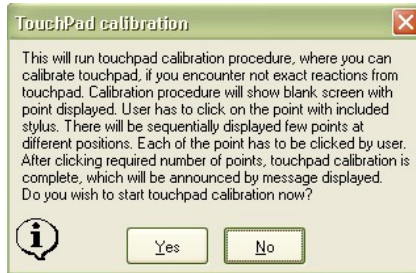

The calibration of touchpad is recommended if you encounter unexpected reactions from touchpad. If user confirms dialog about touchpad calibration with Yes button, calibration procedure will start. Calibration procedure will show blank screen with point displayed. User has to click on the point with stylus. There will be sequentially displayed few points at different positions. Each of the point has to be clicked by user. After clicking required number of points, touchpad calibration is complete, which will be announced by information message displayed.

### Sounds...

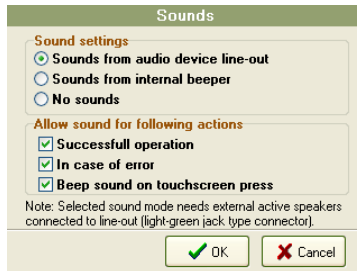

Dialog **Sounds** settings allows user to select the sound mode of program. Program generates sounds after some activities, e.g. activities on device (programming, verifying, reading, etc.). Program generates sound also when warning or error message is displayed. User can now select sound from MS Windows system sound (requires installed sound card), PC speaker or No sound.

The check box “Use beep sound on touch screen press” allows switching beep sound on or off. When the checkbox is checked, beep sound will be generated on each touch screen press, that software detects. Otherwise no beep sound will be generated.



## Options / Statistics...

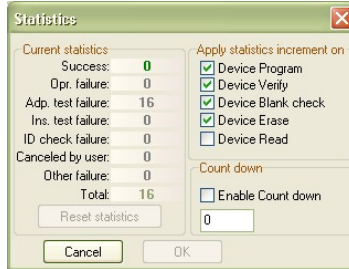

The screenshot shows a dialog box titled "Statistics" with a close button (X) in the top right corner. The dialog is divided into several sections:

- Current statistics:** A list of statistics with their values: Success: 0, Opr. failure: 0, Adp. test failure: 16, Ins. test failure: 0, ID check failure: 0, Canceled by user: 0, Other failure: 0, and Total: 16. Below this list is a "Reset statistics" button.
- Apply statistics increment on:** A list of checkboxes: Device Program (checked), Device Verify (checked), Device Blank check (checked), Device Erase (checked), and Device Read (unchecked).
- Count down:** A checkbox labeled "Enable Count down" (unchecked) and a text input field containing the number "0".
- At the bottom are "Cancel" and "OK" buttons.

Command displays dialog “**Statistics**”. Statistics gives the information about actual count of device operations, which were proceeded on selected type device. If one device is corresponding to one device operation, e.g. programming, the number of device operations will be equal to the number of programmed devices. Statistics dialog contains following options:

Check boxes: Program, Verify, Blank and Erase which define operations, after which statistics values increment.

Any selected and performed device operation will increment the **Total** counter and one of the **Success** or **Failure** counters depending on device operation result (success or failure).

A combination of partial operations is counted as one operation only. For example, a Read operation including Verify after Read is one operation. A Program operation including Erase and/or Verify operations is counted as one operation.

The next function of statistics is **Count down**. Count down allows checking of the number of device operations, and then the number of devices, on which device operations have to be done. After each successful device operation the value of count down counter is decremented. Count down has user defined start number for devices to do. When count down value reach zero, it means, the specified number of devices is complete and a user message about complete count down will be displayed.

Check box **Enable Count down** sets Count down activity (enable or disable). Edit box following the Enable Count down check box defines initial number of count down counter, from which count down starts.

Actual statistics values are displaying in main window of control program in Statistics panel.

**Notes:** When project file is loaded all statistics values are set to zero and Countdown is set to Disabled.

For multiprogramming PG4UWMC software, the statistics information is also saved to Job Summary report.

## Options / View Log...

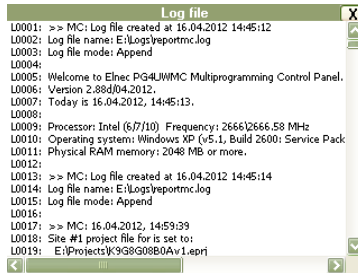

Command displays content of current **Log window**. At top right corner is the button [X], which is used for closing the Log window and displaying of main screen.

## Options / Reset all settings...

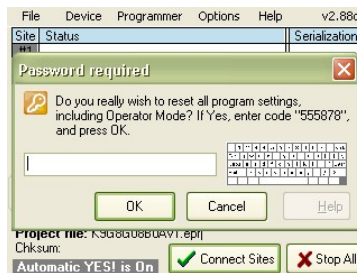

When menu **Reset all settings** is used, Password required dialog will appear, and user will be prompted to enter randomly generated number. After entering correct number and confirming by OK button, all PG4UWMC application settings will be reset to default state. Also Operator Mode will be set to default (Administrator Mode).

## Menu Help

### Help / Index

Menu command displays short help on built-in touch screen. The short help contains brief information about menu commands and basic operations with usage of touch screen.

### Help / Problem report...

Menu command "**Create problem report**" is used for writing more particular diagnostic information to **Log window** and consequently copy **Log window** content to problem report file. Problem report is useful when an error occurs in the control program or programmer and that the user can not resolve and he must contact programmer manufacturer. In this case when customer send message to manufacturer about his problem it is good to send also problem report. Problem report can help manufacturer to localize the reason of error and resolve it sooner.

## Help / Update software...

This important menu command allows users to make software updates. After selecting this item, program will display question **“Are you sure?”**. If user confirms the question with answer **Yes**, dialog **“Select installation package”** will be displayed.

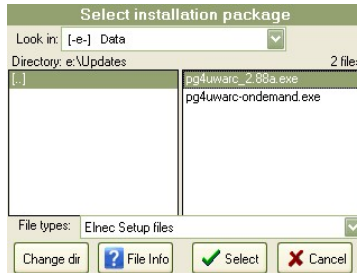

In this dialog user can browse for the **“pg4uwarc.exe”** installation package he wishes to install. The installation package can be copied before, to shared Stand-Alone folder via network, or it can be stored on a USB key which can be plugged into USB port of Stand-Alone programmer. When USB key is plugged to USB port of programmer, new drive letter, assigned with USB key, will appear in list of available drives in dialog **“Select installation package”**. User can then select this drive and run installation package from the USB key.

When user confirms another confirmation dialog, update process will start.



During update process, control program of Stand-Alone programmer is closed, LCD panel can be blank for some moments and after installation is complete, automatic restart of standalone programmer will be performed. Whole process should not exceed time of 1-2 minutes.

## Help / About...

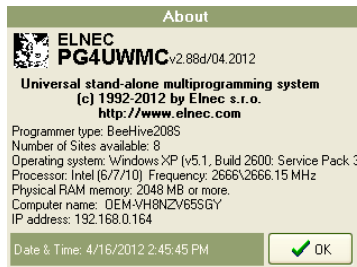

Welcome screen is displayed on standalone's build-in LCD screen after successful starting of standalone control software. The screen can be also displayed by using menu command 'Help / About'. Welcome screen contains following basic information:

- version of control software
- programmer type
- number of Sites available
- operating system
- information about processor and size of installed RAM memory
- computer name and IP address
- system date and time

Welcome screen can be closed by clicking on button **OK**.

## Administration of build in PC

### Introduction

- BeeHive208S Stand-Alone multiprogramming system is powerful programmer equipped with Windows XP Embedded operating system ("OS"). There are two major kinds of administration of the OS – network and local. OS is configured with two users accounts
- **admin**
- **operator**.

Credentials for BeeHive208S Stand-Alone multiprogramming system users are:

	Login	Password
Administrator	admin	saadmin
Operator	operator	saoperator

### Network administration

#### Connecting to network

OS in programmer is configured for operating with **TCP/IP** network. To obtain correct IP address, the configured **DHCP** server must run in your local network, when programmer is starting. After programmer is started it will show **Welcome** screen. On bottom part of screen in line "**IP address:**" is the address obtained from DHCP server. Same information you may find on **About** screen. When IP address is equal to **127.0.0.1**, then no network cable is connected, DHCP server is not running when device start or other kinds of error occur – refer to troubleshooting chapter.

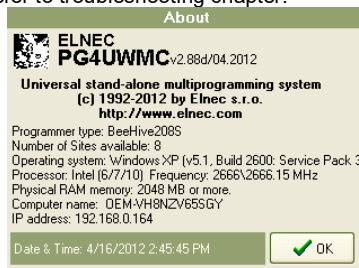

## Remote control

Administering of BeeHive208S Stand-Alone multiprogramming system is performed through Microsoft **“Remote Desktop Connection”**. Remote desktop offers fast and comfortable way to update software (control software and system), distribute project files ...

Find and run **“Remote Desktop Connection”** program on your computer. In **“Computer”** field enter IP address from **Welcome** or **About** screen of standalone programmer.



When communication is established enter administrator credentials.



Because current OS allows only one user connected at a time, next message may be showed.



**Warning:** Connecting to programmer in time, when programming devices is running, programming will be immediately terminated – your devices may not be fully programmed. Restart computer after you finish remote administering.

Because work with remote desktop is similar to working on local station, please continue to read chapter "Local administration".

## Local administration

For local administration of Stand-Alone programmer you **must have connected** standard PS/2 keyboard, PS/2 mouse, and standard analog display with resolution 1024x768 and 32bit color supported.

Operating disk is divided to three volumes. First volume named as "**Recovery**" (C:) contains software for **OS recovery** of programmer to state as shipped from factory. Standard start time of programmer is about 2 minutes. When device doesn't start in 10 minutes, then it may be necessary to perform OS recovery. Before operating system recovery, connect monitor to programmer, and kindly report what you see to programmer manufacturer. For next steps refer to "**Operating system recovery**" chapter. Second volume is "**System**" (D:), and contains **Windows XP Embedded** operating system.

**Warning:** Do not delete, change files or perform any writes on "Recovery" or "System" disk volumes.

Third volume is named as "**Data**" (E:). This volume contains Programmer, Projects, Logs, Updates and Temp directories.

**Programmer** is directory, where main control software is installed. In directory **Logs** are saved log files from operations with devices. When OS update files are available, they should be saved to **Updates** directory. Your project files should be in **Projects** directory. Exact update steps will be distributed with operating system updates.

For programmer reliability operating system is **configured with write filters** on "**Recovery**" and "**System**" disk. As a side effect of these filters, any configuration changes in entire operating system will be **wasted** after restart or shutdown programmer.

### How to make changes in system permanent

If you want persistently save changes on your BeeHive208S follow these steps:

1. run "fbwfmgr.exe /disable" (needed admin rights if you are login as operator, for example with "runas" command from operator account, or login as admin).
2. perform restart BeeHive208S system.
3. make desired changes in your BeeHive208S system.
4. run "fbwfmgr.exe /enable", and restart BeeHive208S immediate. Now should be changes permanent (until system recovery will be performed).

### Operating system recovery

Recovery OS **performs refreshing** of programmer operating system to state as it was **shipped from factory**.

Before operating system recovery, connect monitor to programmer, and kindly report what you see to programmer manufacturer.

To perform operating system recovery you must have connected keyboard, mouse and display. Turn on programmer. After starting BIOS you will see this screen:

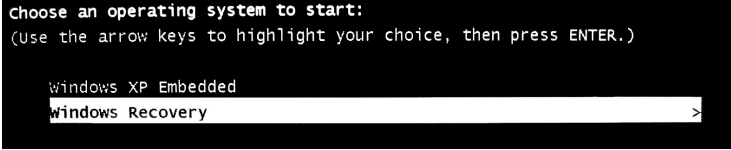

With arrow keys (up or down) select "**Windows Recovery**" and press **Enter**. Recovery system will be started. **Please be patient**. This can take about four minutes. Then **EULA** license will show.

Please **read** carefully this license agreement, **close** window and press "**A**" if you accept this agreement.

Accepting agreement starts **formatting of disk D:**, and installation of control program (recovery **deletes Programmer directory** on disk E:, and creates new one). Also directories Updates and Temp has been erased and recreated. When recovery is completed, you should see "**System recovery completed.**". Then press any key, and system will restart. First start of the operating system after recovery may be a bit longer, with one additional restart.

# Troubleshooting and warranty

## Troubleshooting

We really want you to enjoy our product. Nevertheless, problems can occur. In such cases please follow the instructions below.

- It might be your mistake in not properly operating the programmer or its control program
  - Please read carefully all the enclosed documentation again. Probably you will find the answer right away.
  - Ask your in-house guru (every office has one!).
  - Ask the person who already installed the programmer.
  
- If the problem persists, please call the local dealer, from whom you purchased the programmer, or call ELNEC direct. Most problems can be solved by phone, e-mail or fax. If you want to contact us by:
  - **Mail/fax** - Copy the "**DEVICE PROBLEM REPORT**" form and fill it in following the instructions at the end of the form. Write everything down that you consider being relevant about the programmer, software and the target device. Send the completed form by mail or fax to ELNEC (fax number in the control program, menu **Help / About**) or to your local dealer. If you send the form by fax please use black ink, a good pen and large letters!
  - **E-mail** - Use "**DEVICE PROBLEM REPORT**" form on the CD or from our Internet site and fill it in following the instructions at the end of the form. Use standard ASCII editor. Write everything down that you consider being relevant about the programmer, software and the target device. Send the completed form by e-mail to your local dealer or to ELNEC (**nospam version**) **elnece at elnece dot com**).
  - **Phone** - Copy "**DEVICE PROBLEM REPORT**" form and fill it in following the instructions at the end of the form. Write everything down that you consider being relevant about the programmer, software and the target device. Send the completed form by mail or fax to ELNEC (fax number in the control program, menu **Help / About**) or to your local dealer. If you send the form by fax please use black ink, a good pen and large letters easily to read. Then call your local dealer or ELNEC's customer support center (phone number in the control program, menu **Help / About**). Please keep your manual, the programmer and the completed "**DEVICE PROBLEM REPORT**" form (just faxed) available, so that you can respond quickly to our questions.
  
- If your programmer is diagnosed as defective, consult your local dealer or ELNEC about the pertinent repair center in your country. Please carefully include the following items in the package:
  - defective product
  - completed "**DEVICE PROBLEM REPORT**" form
  - photocopy of a dated proof of purchase



***Without all these items we cannot admit your programmer for repair.***

**Note:**

You may find the **"DEVICE PROBLEM REPORT"** form at our Internet site ([www.elnec.com](http://www.elnec.com)), section **'Support / problem report'**.

## Hardware warnings



*Class A ITE notice*

*Device described in this manual is class A products. In domestic environment this product may cause radio interference in which case the user may be required to take adequate measures.*

- *Because BeeHive208S have internal power supply, follow these special precautions:*
  - *Circuit breakers (overcurrent protection) must be a part of building electrical installation.*
  - *Power cord is a main disconnecting element for disconnecting programmer from mains. Pull out power cord plug from outlet to disconnect programmer from mains.*
- *If you connect programmer to mains by 2 wire cable, or 3 wire power cord is inserted to 2 pin mains plug, for proper prevention before electrical injury you must connect ground wire to black "banana jack for connection to ground" (marked with ground symbol) on the back site of programmer.*

## If you have an unsupported target device

If you need to operate on a target device not supported by the control program for programmer, please do not despair and follow these next steps:

- Look in the device list of the latest version of the control program on our Internet site (section Download, file corresponded to your programmer). Your new target device might already be included in this version! If yes, download the file pg4uwarc.exe and install the new version of the control program.
- Contact ELNEC direct, filling up a **"Device Problem Report"** form following the instructions at the end of this form. We may need detailed data sheets of your target device and, if possible, samples. The samples will be returned to you after we include your target device in a new version of control software.

**Note:**

See also **AlgOR** service at our Internet site ([www.elnec.com](http://www.elnec.com)), section **'Support'**

# Maintenance

We recommend following the instructions and precautions herein to achieve high reliability of the programmer for a long period of time.

The programmer maintenance depends on character and amount of its use. Regardless, the following recommendations are generally accepted:

- Do not use and store the programmer in dusty places.
- Humidity accelerates sedimentation of debris and dust in ZIF socket.
- After end the job cover the ZIF socket of the programmer with enclosed dust cover.
- Do not expose the programmer to direct sunlight or position near a source of heat.

## Daily maintenance

Check the ZIF sockets of the programmer and the socket converters for their condition and wear. Remove debris, dust and grime from the ZIF sockets with clean, dry and compressed air. Clean the ZIF sockets both in closed and opened position.

## Weekly maintenance

Perform the "Selftest plus" for every programming module.

## Quarterly maintenance

Gently clean the surface of the programmer with isopropyl alcohol or technical alcohol on a soft cloth. The LCD clean with a soft cloth moistens in water only. Isopropyl alcohol may damage surface of the LCD. Carefully clean gap between top cover and display. A lot of dust or grime may cause an unwanted touch on touch screen.

Perform the calibration test using 48 Pins Calibration test POD, Type I.

## Biannual maintenance

Check amount of dust or dirty in programmer. If you feel that a lot of dust or dirty is in programmer, clear it by vacuum cleaner.

The warranty does not apply to any damage of programmer or its part caused by dust or dirt.

Contact Elnec if you prefer to order this service by manufacturer.

## Warning:

*The ZIF socket of the programmer and the socket converters are considered as consumables. The life cycle of the ZIF socket of the programmer' is about 25.000 mechanical cycles. The life cycle of ZIF sockets of the socket converters is in generally from 5.000 to 10.000 mechanical cycles, even if the life cycle of some specialized BGA ZIF sockets can be about 500.000 mechanical cycles. Programmed devices, environment and ZIF maintenance have direct influence to actual electrical lifetime of ZIF socket (it means that ZIF socket does not cause programming failures yet). Keep fingers away from contacts of ZIF socket, because contacts of the ZIF socket fouled by smear and grime from fingers may cause the programming failures. Change the ZIF socket or the socket converter if you noticed increased number of programming failures.*

*The warranty does not apply to the ZIF sockets that are wear or grimy and which cause large amount of failures during working with programmer.*

# Warranty terms

The manufacturer, ELNEC s.r.o. Presov, Slovakia, gives a guarantee on failure-free operating of the BeeHive208S Stand-Alone multiprogramming system, including protective circuits, original brand components, and careful manufacturing and hours-

long burning-in allows us to provide a three-year warranty on parts and labor for the programmer (limited 25 000-cycle warranty on ZIF sockets or 10,000-cycles on other ZIF sockets). Although we take as much care as possible to integrate high quality components in the build in computer, we can't provide higher warranty as we get from suppliers. So there is a limited warranty of one year on all computer parts such as touch screen, motherboard, CPU, HD, ...

If the product is diagnosed as defective, ELNEC s.r.o. or the authorized repair centre will repair or replace defective parts at no charge. Parts used for replacement and/or whole programmer are warranted only for the remainder of the original warranty period.

For repair within the warranty period, the customer must prove the date of purchase.

These warranty terms are valid for customers, who purchase a programmer directly from Elnec. The warranty conditions of Elnec sellers may differ depending on the target country law system or Elnec seller's warranty policy.

The warranty does not apply to products that are of wear and tear or mechanically damaged. The warranty does not apply to any damage of programmer or its part caused by dust or dirt. Equally, the warranty does not apply to products opened and/or repaired and/or altered by personnel not authorized by ELNEC, or to products that have been misused, abused, accidentally damaged or that were improperly installed.

For unwarrantable repairs you will be billed according to the costs of replacement materials, service time and carriage. ELNEC or its distributors will determine whether the defective product should be repaired or replaced and judge whether or not the warranty applies.

**Manufacturer:**

✉: **ELNEC s. r. o.**, Jana Bottu 5, SK - 08001 Presov, Slovakia  
☎: +42151/77 34 328, 77 31 007, fax 77 32 797  
[www.elnec.com](http://www.elnec.com), e-mail (nospam version): elnec at elnec dot com

ELNEC has used its best efforts to develop hardware and software that is stable and reliable. ELNEC does not guarantee that the hardware and software are free of "bugs", errors or defects. ELNEC's liability is always limited to contract's net value paid by a buyer.

ELNEC is not liable for:

- Damage caused by inappropriate use or handling of products.
- Damage caused by users or third parties modifying or trying to modify products.
- Any further damage or consequent damage caused by hardware errors or software "bugs".
- Damage caused by viruses, root kits and so on.

**For example:** *lost profits, lost savings, damages arised from claims of third parties against a client, damage or loss of recorded data or files, renown, loss caused by impossibility to use etc.*